

G3VM-□CR□/□FR□

MOS FET Relays DIP 8-pin, High-Current and Low-ON-resistance Type

The highest class load current of MOS FET Relays realized with DIP8 package

- Contact form: 1a (SPST-NO)
- Load voltage: 60 V, 100 V, 200 V, 400 V, or 600 V
- 60-V Relay: Continuous load current of 5 A (10 A) max. *
- 100-V Relay: Continuous load current of 3 A (6 A) max. *
- 200-V Relay: Continuous load current of 1.5 A (3 A) max. *
- 400-V Relay: Continuous load current of 0.4 A (0.8 A) max. *
- 600-V Relay: Continuous load current of 0.6 A (1.2 A) max. *

* Values in parentheses are for connection C.



NEW

Note: The actual product is marked differently from the image shown here.

RoHS Compliant

Application Examples

- Communication equipment
- Industrial equipment
- Test & Measurement equipment
- Power circuit
- Security equipment

Package (Unit : mm, Average)

DIP 8-pin
PCB Terminals

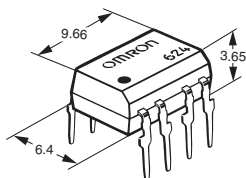

Surface-mounting Terminals

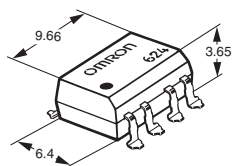

Note: The actual product is marked differently from the image shown here.

Model Number Legend

G3VM-□□□□□
1 2 3 4 5

1. Load Voltage

- 6 : 60 V
- 10 : 100 V
- 20 : 200 V
- 40 : 400 V
- 60 : 600 V

2. Contact form

- 1 : 1a (SPST-NO)

3. Package

- C : DIP 8-pin with PCB terminals
- F : DIP 8-pin with surface-mounting terminals

4. Additional functions

- R : Low ON resistance

5. Other informations

When specifications overlap, serial code is added in the recorded order.

Ordering Information

Package	Contact form	Load voltage (peak value) *	Continuous load current (peak value) *	Stick packaging			Tape packaging	
				Model		Minimum package quantity	Model	Minimum package quantity
				PCB Terminals	Surface-mounting Terminals		Surface-mounting Terminals	
DIP8	1a (SPST-NO)	60 V	5 A	G3VM-61CR1	G3VM-61FR1	50 pcs.	G3VM-61FR1(TR05)	500 pcs.
		100 V	3 A	G3VM-101CR	G3VM-101FR		G3VM-101FR(TR05)	
		200 V	1.5 A	G3VM-201CR	G3VM-201FR		G3VM-201FR(TR05)	
		400 V	0.4 A	G3VM-401CR	G3VM-401FR		G3VM-401FR(TR05)	
		600 V	0.6 A	G3VM-601CR	G3VM-601FR		G3VM-601FR(TR05)	

* The AC peak and DC value are given for the load voltage and continuous load current.

Note: To order tape packaging for Relays with surface-mounting terminals, add "(TR05)" to the end of the model number.

■ Absolute Maximum Ratings (Ta = 25°C)

Item		Symbol	G3VM-61CR1 G3VM-61FR1	G3VM-101CR G3VM-101FR	G3VM-201CR G3VM-201FR	G3VM-401CR G3VM-401FR	G3VM-601CR G3VM-601FR	Unit	Measurement conditions	
Input	LED forward current	I _F	30					mA		
	Repetitive peak LED forward current	I _{FP}	1					A	100 μs pulses, 100 pps	
	LED forward current reduction rate	ΔI _F /°C	-0.3					mA/°C	Ta ≥ 25°C	
	LED reverse voltage	V _R	5					V		
	Connection temperature	T _J	125					°C		
Load voltage (AC peak/DC)		V _{OFF}	60	100	200	400	600	V		
Output	Continuous load current	Connection A	5	3	1.5	0.4	0.6	A	Connection A: AC peak/DC Connection B and C: DC	
		Connection B	5	3	1.5	0.4	0.6			
		Connection C	10	6	3	0.8	1.2			
	ON current reduction rate	Connection A	ΔI _O /°C	-50	-30	-15	-4	-6	mA/°C	Ta ≥ 25°C
		Connection B	-50	-30	-15	-4	-6			
		Connection C	-100	-60	-30	-8	-12			
Pulse ON current		I _{OP}	15	9	4.5	1.2	1.8	A	t=100 ms, Duty=1/10	
Connection temperature		T _J	125					°C		
Dielectric strength between I/O *		V _{I-O}	2,500					V _{rms}	AC for 1 min	
Ambient operating temperature		T _a	-40 to +85	-40 to +110		-40 to +85		°C	With no icing or condensation	
Ambient storage temperature		T _{stg}	-55 to +125					°C	condensation	
Soldering temperature		-	260					°C	10 s	

* The dielectric strength between the input and output was checked by applying voltage between all pins as a group on the LED side and all pins as a group on the light-receiving side.

Connection Diagram

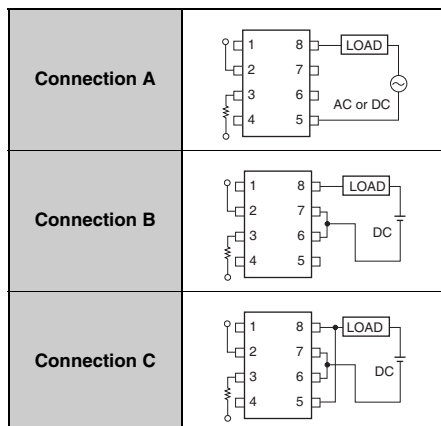

■Electrical Characteristics (Ta = 25°C)

Item	Symbol		G3VM-61CR1	G3VM-101CR	G3VM-201CR	G3VM-401CR	G3VM-601CR	Unit	Measurement conditions	
			G3VM-61FR1	G3VM-101FR	G3VM-201FR	G3VM-401FR	G3VM-601FR			
LED forward voltage	V _F	Minimum	1.5					V	I _F =10 mA	
		Typical	1.64							
		Maximum	1.8							
Reverse current	I _R	Maximum	10					μA	V _R =5 V	
Capacitance between terminals	C _T	Typical	70					pF	V=0, f=1MHz	
Trigger LED forward current	I _{FT}	Typical	0.28	0.3	0.3	0.2	0.23	mA	G3VM-61CR1/FR1 : I _o =1 A G3VM-101CR/FR : I _o =1 A G3VM-201CR/FR : I _o =1 A G3VM-401CR/FR : I _o =0.4 A G3VM-601CR/FR : I _o =0.6 A	
		Maximum	5	5	5	1	5			
Release LED forward current	I _{FC}	Minimum	0.01					mA	G3VM-61CR1/FR1 : I _{OFF} =1 μA G3VM-101CR/FR : I _{OFF} =1 μA G3VM-201CR/FR : I _{OFF} =1 μA G3VM-401CR/FR : I _{OFF} =10 μA G3VM-601CR/FR : I _{OFF} =1 μA	
		Typical	0.19	-	-	0.19	0.17			
Maximum resistance with output ON	R _{ON}	Connection A	Typical	0.022	0.06	0.25	3	1.3	Ω	G3VM-61CR1/FR1 : I _o =1 A, I _F =5 mA, t < 1 s G3VM-101CR/FR : I _o =1 A, I _F =5 mA, t < 1 s G3VM-201CR/FR : I _o =1 A, I _F =5 mA, t < 1 s G3VM-401CR/FR : I _o =0.4 A, I _F =2 mA, t < 1 s G3VM-601CR/FR : I _o =0.6 A, I _F =5 mA, t < 1 s
			Maximum	0.05	0.15	0.5	5	2		
		Connection B	Maximum	0.025	0.075	0.25	2.5	1		
Maximum resistance with output ON	R _{ON}	Connection C	Maximum	0.013	0.038	0.125	1.3	0.5	Ω	G3VM-61CR1/FR1 : I _o =1 A, I _F =2 mA, t < 1 s G3VM-101CR/FR : I _o =1 A, I _F =5 mA, t < 1 s G3VM-201CR/FR : I _o =1 A, I _F =5 mA, t < 1 s G3VM-401CR/FR : I _o =0.4 A, I _F =2 mA, t < 1 s G3VM-601CR/FR : I _o =0.6 A, I _F =2 mA, t < 1 s
		Maximum	0.013	0.038	0.125	1.3	0.5			
Current leakage when the relay is open	I _{LEAK}	Typical	0.01	0.02	0.1	0.001	0.05	μA	V _{OFF} =Load Voltage Ratings	
		Maximum	10	1	1	1	10			
Capacitance between terminals	C _{OFF}	Typical	850	720	400	410	4,300	pF	V=0, f=1 MHz	
Capacitance between I/O terminals	C _{I-O}	Typical	0.8					pF	f=1 MHz, V _s =0 V	
Insulation resistance between I/O terminals	R _{I-O}	Minimum	1,000					MΩ	V _{I-O} =500 VDC, R _{oH} ≤60%	
		Typical	10 ⁸							
Turn-ON time	t _{ON}	Typical	2.5	1.5	0.25	0.22	0.8	ms	I _F =5 mA, R _L =200 Ω, V _{DD} =20 V *	
		Maximum	5							
Turn-OFF time	t _{OFF}	Typical	0.1					ms	I _F =5 mA, R _L =200 Ω, V _{DD} =20 V *	
		Maximum	1							

* Turn-ON and Turn-OFF Times

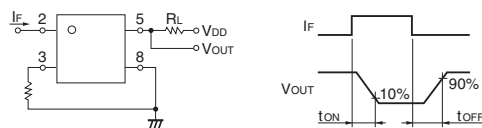

■Recommended Operating Conditions

For usage with high reliability, Recommended Operation Conditions is a measure that takes into account the derating of Absolute Maximum Ratings and Electrical Characteristics.

Each item on this list is an independent condition, so it is not simultaneously satisfy several conditions.

Item	Symbol		G3VM-61CR1	G3VM-101CR	G3VM-201CR	G3VM-401CR	G3VM-601CR	Unit
			G3VM-61FR1	G3VM-101FR	G3VM-201FR	G3VM-401FR	G3VM-601FR	
Load voltage (AC peak/DC)	V _{DD}	Maximum	48	80	160	320	480	V
Operating LED forward current	I _F	Typical	5	5	5	2	5	mA
		Maximum	25					
Continuous load current (AC peak/DC)	I _o	Maximum	5	3	1.5	0.4	0.6	A
Ambient operating temperature	T _a	Minimum	-40					°C
		Maximum	85					

■Spacing and Insulation

Item	Minimum	Unit
Creepage distances	7.0	mm
Clearance distances	7.0	
Internal isolation thickness	0.4	

Engineering Data

LED forward current vs. Ambient temperature

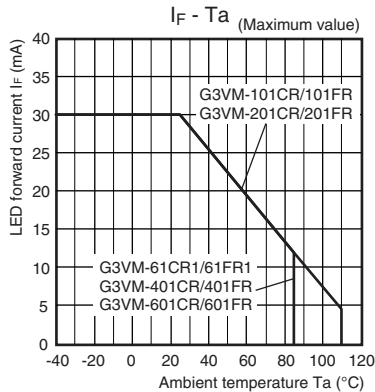

LED forward current vs. LED forward voltage

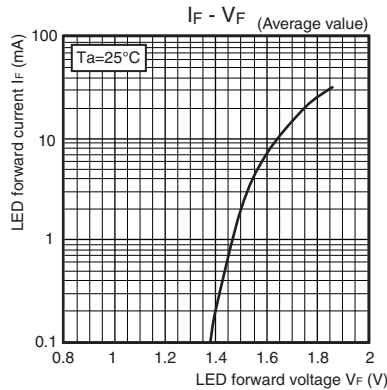

On-state resistance vs. Ambient temperature

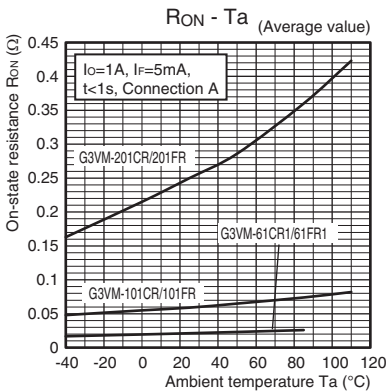

Continuous load current vs. Ambient temperature

G3VM-61CR1/61FR1
G3VM-101CR/101FR/201CR/201FR

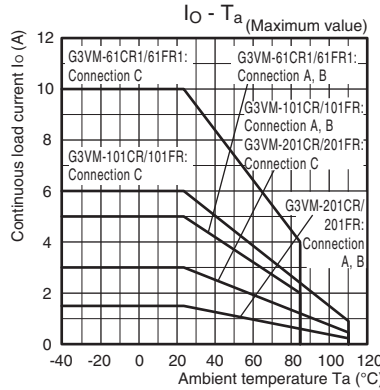

Continuous load current vs. On-state voltage

G3VM-61CR1/61FR1
G3VM-101CR/101FR/201CR/201FR

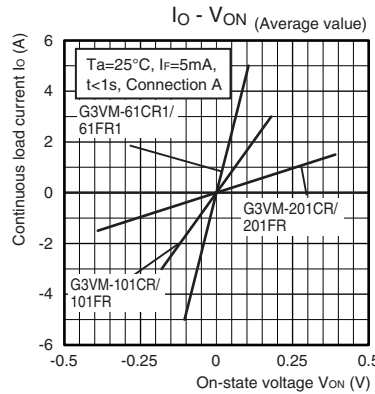

G3VM-401CR/401FR/601CR/601FR

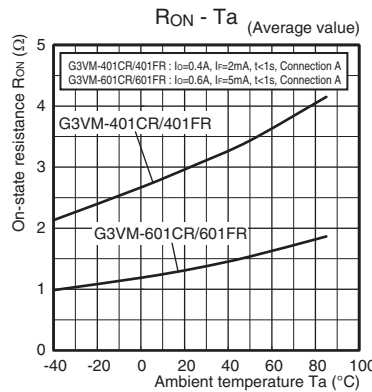

G3VM-401CR/401FR/601CR/601FR

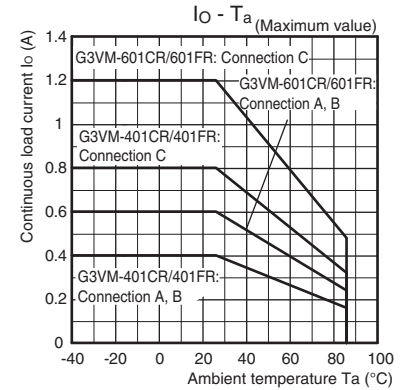

G3VM-401CR/401FR/601CR/601FR

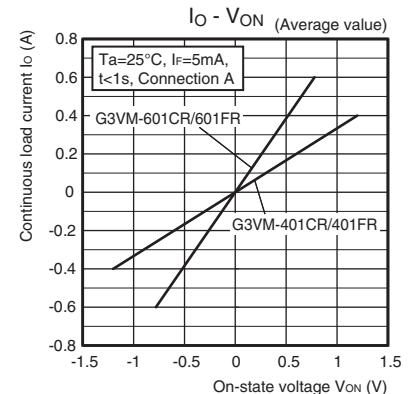

Trigger LED forward current vs. Ambient temperature

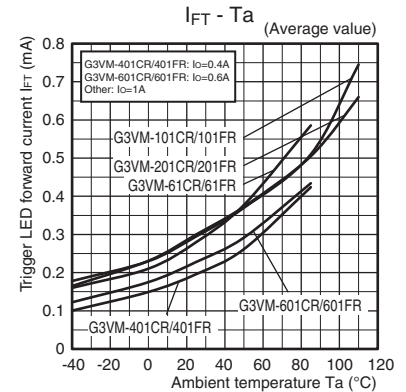

DIP

G3VM-□CR□/□FR□

Engineering Data

Turn ON, Turn OFF time vs. LED forward current

G3VM-61CR1/61FR1

G3VM-401CR/401FR/601CR/601FR

G3VM-101CR/101FR/201CR/201FR

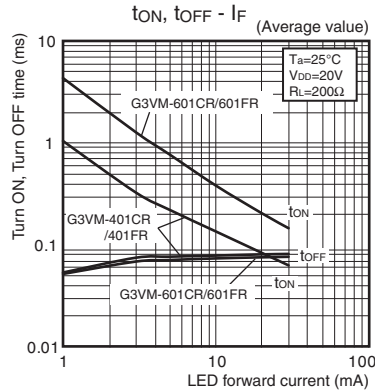
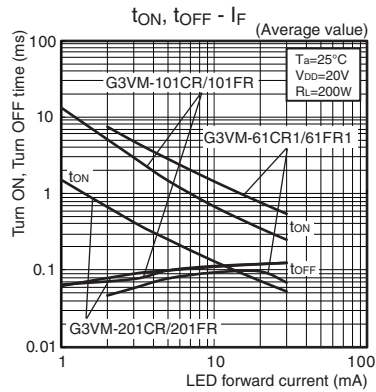

Turn ON, Turn OFF time vs. Ambient temperature

G3VM-61CR1/61FR1

G3VM-401CR/401FR/601CR/601FR

G3VM-101CR/101FR/201CR/201FR

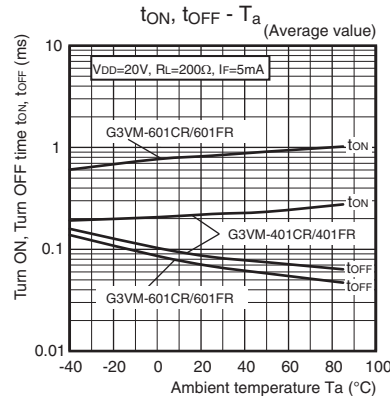
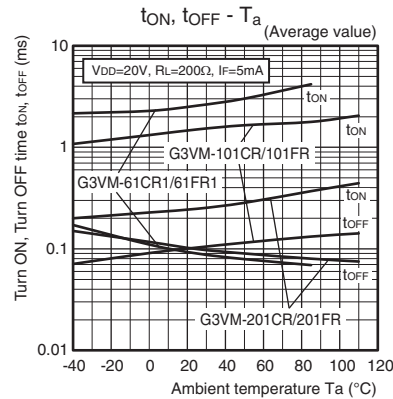

Current leakage vs. Ambient temperature

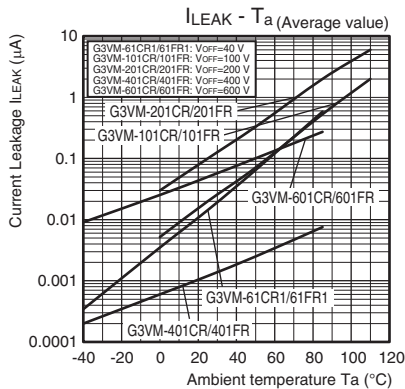

Appearance / Terminal Arrangement / Internal Connections

Appearance

DIP (Dual Inline Package)

DIP 8-pin

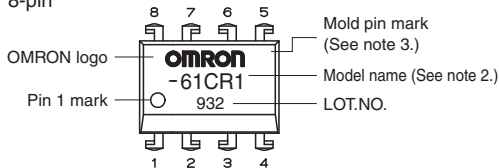

Terminal Arrangement/Internal Connections (Top View)

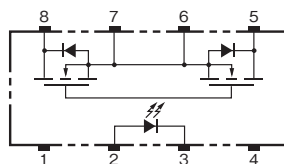

Note: 1. The actual product is marked differently from the image shown here.

Note: 2. "G3VM" does not appear in the model number on the Relay.

Note: 3. The indentation in the corner diagonally opposite from the pin 1 mark is from a pin on the mold.

■Dimensions (Unit: mm)

DIP 8-pin



PCB Terminals

Weight: 0.54 g

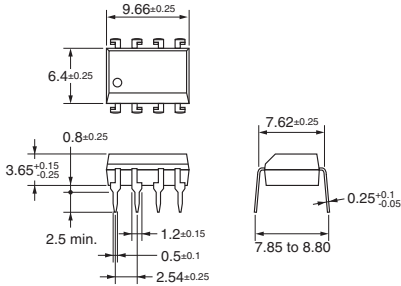

Surface-mounting Terminals

Weight: 0.54 g

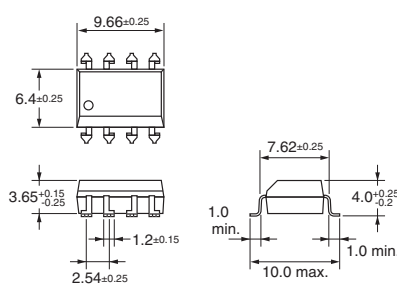
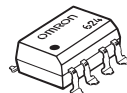

PCB Dimensions (BOTTOM VIEW)

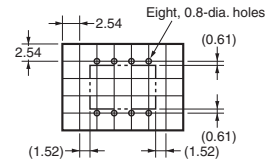

Actual Mounting Pad Dimensions

(Recommended Value, Top View)

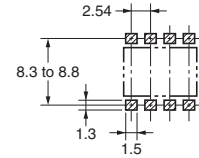

Note: The actual product is marked differently from the image shown here.

■Approved Standards

UL recognized

Model	Approved Standards	Contact form	File No.
G3VM-61CR1 G3VM-61FR1	UL (recognized)	1a (SPST-NO)	E80555
G3VM-101CR G3VM-101FR			
G3VM-201CR G3VM-201FR			
G3VM-401CR G3VM-401FR			
G3VM-601CR G3VM-601FR			
G3VM-601CR G3VM-601FR			

■Safety Precautions

- Refer to the *Common Precautions for All MOS FET Relays* for precautions that apply to all MOS FET Relays.

Please check each region's Terms & Conditions by region website.

OMRON Corporation

Electronic and Mechanical Components Company

Regional Contact

Americas
<https://www.components.omron.com/>

Asia-Pacific
<https://ecb.omron.com.sg/>

Korea
<https://www.omron-ecb.co.kr/>

Europe
<http://components.omron.eu/>

China
<https://www.ecb.omron.com.cn/>

Japan
<https://www.omron.co.jp/ecb/>